

Display CARFAX in online listings:



This report provided free of charge by:

**The Car Connect Auto Group**

13409 Garvey Ave Ste 6  
Baldwin Park, CA 91706

626-649-3598



## Vehicle History Report™

US \$44.99

### 2012 TOYOTA SIENNA SE 8-PASSENGER

VIN: 5TDXK3DC5CS274553  
VAN  
3.5L V6 F DOHC 24V  
GASOLINE  
FRONT WHEEL DRIVE

This CARFAX Report Provided  
by:  
**The Car Connect Auto  
Group**

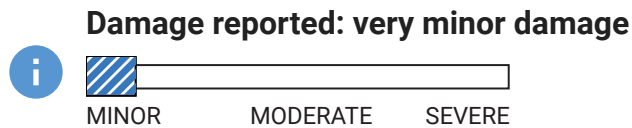

**15** Service history records

**2** Previous owners

**Types of owners: Personal lease, Personal**

**165,582** Last reported odometer reading



This CARFAX Vehicle History Report is based only on information supplied to CARFAX and available as of 9/30/24 at 2:34:06 PM (CDT). Other information about this vehicle, including problems, may not have been reported to CARFAX. Use this report as one important tool, along with a vehicle inspection and test drive, to make a better decision about your next used car.



### Accident / Damage History

Not all accidents / issues are reported to CARFAX

#### Event 1

05/22/2021

**Damage reported: very  
minor damage**

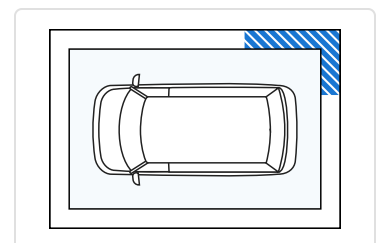
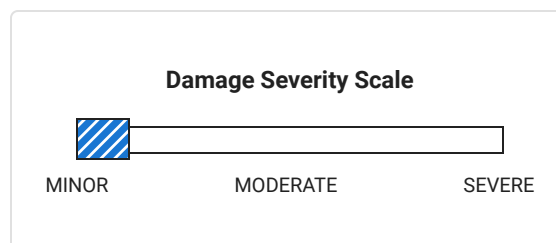

 <b>Additional History</b> Not all accidents / issues are reported to CARFAX	Owner 1	Owner 2
<b>Total Loss</b> No total loss reported to CARFAX.	<input checked="" type="checkbox"/> No Issues Reported	<input checked="" type="checkbox"/> No Issues Reported
<b>Structural Damage</b> CARFAX recommends that you have this vehicle inspected by a collision repair specialist.	<input checked="" type="checkbox"/> No Issues Reported	<input checked="" type="checkbox"/> No Issues Reported
<b>Airbag Deployment</b> No airbag deployment reported to CARFAX.	<input checked="" type="checkbox"/> No Issues Reported	<input checked="" type="checkbox"/> No Issues Reported
<b>Odometer Check</b> No indication of an odometer rollback.	<input checked="" type="checkbox"/> No Issues Indicated	<input checked="" type="checkbox"/> No Issues Indicated
<b>Accident / Damage</b> Damage reported: 05/22/2021.	<input checked="" type="checkbox"/> No Issues Reported	Very Minor Damage
<b>Manufacturer Recall</b> No open recalls reported to CARFAX. Check with an authorized Toyota dealer for any open recalls. View Toyota disclosure	<input checked="" type="checkbox"/> No Recalls Reported	<input checked="" type="checkbox"/> No Recalls Reported
<b>Basic Warranty</b> Original warranty estimated to have expired.	<b>Warranty Expired</b>	<b>Warranty Expired</b>

 <b>Title History</b> CARFAX guarantees the information in this section	Owner 1	Owner 2
<b>Damage Brands</b> Salvage   Junk   Rebuilt   Fire   Flood   Hail   Lemon	<input checked="" type="checkbox"/> <b>Guaranteed</b> No Problem	<input checked="" type="checkbox"/> <b>Guaranteed</b> No Problem
<b>Odometer Brands</b> Not Actual Mileage   Exceeds Mechanical Limits	<input checked="" type="checkbox"/> <b>Guaranteed</b> No Problem	<input checked="" type="checkbox"/> <b>Guaranteed</b> No Problem



**GUARANTEED** - None of these title problems were reported by a U.S. state Department of Motor Vehicles (DMV). If you find that any of these title problems were reported by a DMV and not included in this report, you may qualify. [View Terms](#) | [View Certificate](#)

 <b>Ownership History</b> The number of owners is estimated	Owner 1	Owner 2
Year purchased	2012	2014
Type of owner	Personal lease	Personal
Estimated length of ownership	1 yr. 10 mo.	6 yrs. 3 mo.
Owned in the following states/provinces	California	California
Estimated miles driven per year	---	15,125/yr

Last reported odometer reading

162

165,582



## Detailed History



## Owner 1

Purchased: 2012

Personal Lease  
Vehicle

Date	Mileage	Source	Comments
07/09/2012		NICB	<b>Vehicle manufactured and shipped to California</b>
07/28/2012	1	Toyota of Poway Poway, CA 858-486-2900 toyotaofpoway.com ★ 4.5 / 5.0 869 Verified Reviews ❤️ 8,488 Customer Favorites	<b>Vehicle serviced</b> - Pre-delivery inspection completed
07/29/2012		Toyota of Poway Poway, CA 858-486-2900 toyotaofpoway.com ★ 4.5 / 5.0 869 Verified Reviews ❤️ 8,488 Customer Favorites	<b>Vehicle offered for sale</b>
09/14/2012	162	Toyota of Poway Poway, CA 858-486-2900 toyotaofpoway.com ★ 4.5 / 5.0 869 Verified Reviews ❤️ 8,488 Customer Favorites	<b>Vehicle sold</b>
10/03/2012		California Motor Vehicle Dept. Valencia, CA	<b>Title issued or updated</b> - First owner reported - Titled or registered as personal lease vehicle - Loan or lien reported









## Owner 2

Purchased: 2014















Personal Vehicle  
15,125 mi/yr

Date	Mileage	Source	Comments
08/12/2014	25,230	California	<b>Odometer reading reported</b>

Motor Vehicle Dept.  
Shafter, CA

09/04/2014		California Motor Vehicle Dept. Shafter, CA		<b>Title issued or updated</b> - New owner reported - Loan or lien reported
10/01/2014	29,095	Bill Wright Toyota Bakersfield, CA 661-398-8697 billwrighttoyota.com ★ 4.5 / 5.0 103 Verified Reviews		<b>Vehicle serviced</b> - 30,000 mile service performed - Tire condition and pressure checked
02/14/2015	37,514	Bill Wright Toyota Bakersfield, CA 661-398-8697 billwrighttoyota.com ★ 4.5 / 5.0 103 Verified Reviews		<b>Vehicle serviced</b> - 35,000 mile service performed - Tire condition and pressure checked
08/01/2015	47,722	Bill Wright Toyota Bakersfield, CA 661-398-8697 billwrighttoyota.com ★ 4.5 / 5.0 103 Verified Reviews		<b>Vehicle serviced</b> - 40,000 mile service performed - Tire condition and pressure checked
12/05/2015	55,135	Bill Wright Toyota Bakersfield, CA 661-398-8697 billwrighttoyota.com ★ 4.5 / 5.0 103 Verified Reviews		<b>Vehicle serviced</b> - Tire condition and pressure checked - Oil and filter changed - Air filter replaced - Air filter checked - Cabin air filter checked
02/22/2017	66,686	Bill Wright Toyota Bakersfield, CA 661-398-8697 billwrighttoyota.com/ ★ 4.8 / 5.0 71 Verified Reviews ❤️ 168 Customer Favorites		<b>Vehicle serviced</b> - Maintenance inspection completed - Recommended maintenance performed - 70,000 mile service performed - Air filter replaced - Brake fluid flushed/changed - Front brakes replaced - Tire condition and pressure checked - Front brake pads replaced - Brakes checked - Cabin air filter checked
11/04/2017	75,185	Bill Wright Toyota Bakersfield, CA 661-398-8697 billwrighttoyota.com/ ★ 4.8 / 5.0 71 Verified Reviews		<b>Vehicle serviced</b> - Tire condition and pressure checked - Oil and filter changed - Brakes checked

 **168** Customer Favorites

08/08/2018	86,033	California Inspection Station		<b>Passed emissions inspection</b>
09/01/2018	86,687	Bill Wright Toyota Bakersfield, CA 661-398-8697 billwrighttoyota.com/  <b>4.8 / 5.0</b> 71 Verified Reviews  <b>168</b> Customer Favorites		<b>Vehicle serviced</b> - Tire condition and pressure checked - Oil and filter changed
11/10/2018	89,126	Bill Wright Toyota Bakersfield, CA 661-398-8697 billwrighttoyota.com/  <b>4.8 / 5.0</b> 71 Verified Reviews  <b>168</b> Customer Favorites		<b>Vehicle serviced</b> - Tire condition and pressure checked - Seatbelts checked
06/05/2019	98,080	Bill Wright Toyota Bakersfield, CA 661-398-8697 billwrighttoyota.com/  <b>4.8 / 5.0</b> 71 Verified Reviews  <b>168</b> Customer Favorites		<b>Vehicle serviced</b> - Air filter replaced - Oil and filter changed - Tire condition and pressure checked - Interior trim checked - Cabin air filter replaced/cleaned
08/20/2019		California Motor Vehicle Dept. Shafter, CA		<b>Title issued or updated</b> - Loan or lien released
11/14/2020		Keyes Lexus Van Nuys, CA  <b>4.5 / 5.0</b> 526 Verified Reviews  <b>9,039</b> Customer Favorites		<b>Vehicle offered for sale</b>
03/11/2021	115,364	Shafter Express Oil Service Shafter, CA 661-746-5465  <b>4.9 / 5.0</b> 29 Verified Reviews  <b>13</b> Customer Favorites		<b>Vehicle serviced</b> - Maintenance inspection completed - Oil and filter changed
03/18/2021	115,704	California Inspection Station		<b>Passed emissions inspection</b>

05/22/2021

Damage Report



**Damage reported: very minor damage**

- Damage to right rear



**CARFAX HAS THE MOST ACCIDENT & DAMAGE INFORMATION**

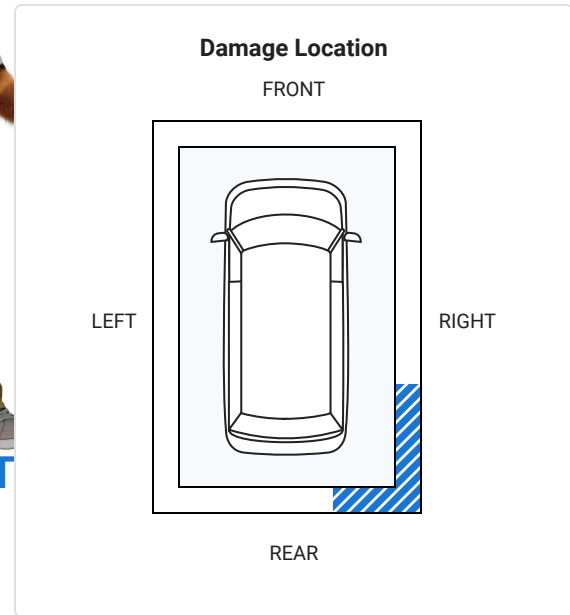
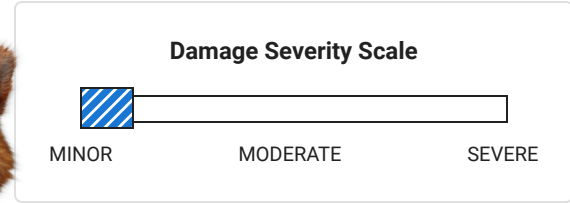

Minor damage is usually cosmetic, including dents or scratches to the vehicle body.

11/21/2022    139,463

Shafter Express Oil Service  
Shafter, CA  
661-746-5465

★ **4.9 / 5.0**  
29 Verified Reviews  
♥ **13** Customer Favorites



**Vehicle serviced**

- Maintenance inspection completed  
- Oil and filter changed

12/20/2022    141,446

California Inspection Station

**Passed emissions inspection**

06/17/2023    149,040



Shafter Express Oil Service  
Shafter, CA  
661-746-5465

★ **4.9 / 5.0**  
29 Verified Reviews  
♥ **13** Customer Favorites



**Vehicle serviced**

- Maintenance inspection completed  
- Oil and filter changed

06/27/2023		Big Brand Tire Wasco, CA 661-758-5227 bigbrandtire.com/ ★ 5.0 / 5.0 11 Verified Reviews	 <b>Vehicle serviced</b> - Tires rotated
08/09/2024	165,581	Merced Chevrolet Merced, CA 209-383-3306 chevroletofmerced.com ★ 4.7 / 5.0 103 Verified Reviews ❤️ 2,571 Customer Favorites	<b>Vehicle offered for sale</b>
08/16/2024		Online Listing	<b>Vehicle offered for sale</b>
08/19/2024		Auto Auction	<b>Vehicle sold</b>
			Millions of used vehicles are bought and sold at auction every year.
08/21/2024		California Motor Vehicle Dept. Merced, CA	<b>Title issued or updated</b> - Dealer took title of this vehicle while it was in inventory
08/26/2024	165,582	Ac Smog Test Only Baldwin Park, CA 626-960-7170 ★ 5.0 / 5.0 5 Verified Reviews ❤️ 1 Customer Favorite	 <b>Vehicle serviced</b> - Emissions inspection performed
08/26/2024		California Inspection Station	<b>Passed emissions inspection</b>

Have Questions? Consumers, please visit our Help Center at [www.carfax.com](http://www.carfax.com). Dealers or Subscribers, please visit our Help Center at [www.carfaxonline.com](http://www.carfaxonline.com).



### Glossary

#### Damage Indicator

Damage can be a result of many different types of events. Examples include contact with objects (other cars, trees, traffic signs, road debris, etc), vandalism, or weather-related events. Not every damage event is reported to CARFAX. As details about the damage event become available, those additional details are added to the CARFAX Vehicle History Report. CARFAX recommends that you have this vehicle inspected by a qualified mechanic.

- This CARFAX Vehicle History Report is based only on information supplied to CARFAX and available as of 9/30/24 at 2:34:06 PM (CDT). Other information about this vehicle, including problems, may not have

been reported to CARFAX. Use this report as one important tool, along with a vehicle inspection and test drive, to make a better decision about your next used car.

### Damage Severity

Damage events result in one of the following severity levels:

- **Minor:** Generally, minor damage is cosmetic (including dents or scratches), may only require reconditioning, and typically does not compromise a vehicle's operation and/or safety.
- **Moderate:** Moderate damage may affect multiple components of the vehicle and may impair the vehicle's operation and/or safety.
- **Severe:** Severe damage usually affects multiple components of the vehicle and is likely to compromise the vehicle's operation and/or safety.

CARFAX recommends getting a pre-purchase inspection at a certified collision repair facility.

### First Owner

When the first owner(s) obtains a title from a Department of Motor Vehicles as proof of ownership.

### New Owner Reported

When a vehicle is sold to a new owner, the Title must be transferred to the new owner(s) at a Department of Motor Vehicles.

### Ownership History

CARFAX defines an owner as an individual or business that possesses and uses a vehicle. Not all title transactions represent changes in ownership. To provide estimated number of owners, CARFAX proprietary technology analyzes all the events in a vehicle history. Estimated ownership is available for vehicles manufactured after 1991 and titled solely in the US including Puerto Rico. Dealers sometimes opt to take ownership of a vehicle and are required to in the following states: Maine, Massachusetts, New Jersey, Ohio, Oklahoma, Pennsylvania and South Dakota. Please consider this as you review a vehicle's estimated ownership history.

### Title Issued

A state issues a title to provide a vehicle owner with proof of ownership. Each title has a unique number. Each title or registration record on a CARFAX report does not necessarily indicate a change in ownership. In Canada, a registration and bill of sale are used as proof of ownership.

### Toyota Recall / Service Campaign

Portions of this report have been included under license from Toyota Motor North America, Inc. ("TOYOTA"), License Agreement TMS1013 . This data applies only to vehicle marketed or originally sold in Mexico and the United States of America, including Guam, Saipan, American Samoa, Puerto Rico, the U.S. Virgin Islands and the other United States territories and protectorates with currently open safety or emissions recalls, or service campaigns. While TOYOTA provides data to Carfax Inc. on a regular basis, this report may not include very recent activity. For the manufacturer's most current information on recall/campaign activity for any Toyota, Lexus or Scion brand vehicle, you must go to <http://toyota.com/recall> or <http://lexus.com/recall>.

Follow Us:



[facebook.com/CARFAX](https://www.facebook.com/CARFAX)



[@CARFAXinc](https://twitter.com/CARFAXinc)



About CARFAX

CARFAX DEPENDS ON ITS SOURCES FOR THE ACCURACY AND RELIABILITY OF ITS INFORMATION. THEREFORE, NO RESPONSIBILITY IS ASSUMED BY CARFAX OR ITS AGENTS FOR ERRORS OR OMISSIONS IN THIS REPORT. CARFAX FURTHER EXPRESSLY DISCLAIMS ALL WARRANTIES, EXPRESS OR IMPLIED, INCLUDING ANY IMPLIED WARRANTIES OF MERCHANTABILITY OR FITNESS FOR A PARTICULAR PURPOSE.

© 2024 CARFAX, Inc., part of S&P Global. All rights reserved.

9/30/24 2:34:06 PM (CDT)

**I have reviewed and received a copy of the CARFAX Vehicle History Report for this 2012 TOYOTA SIENNA vehicle (VIN: 5TDXK3DC5CS274553), which is based on information supplied to CARFAX and available as of 9/30/24 at 3:34 PM (EDT).**

Customer Signature

Date

Dealer Signature

Date